

Varenummer: 203160M16150B2T
 Beskrivelse: E+G Justerfod
 GN 31-60-M16-150-B2-T
 Note: T Uden møtrik, spændeflade i bunden

Mål

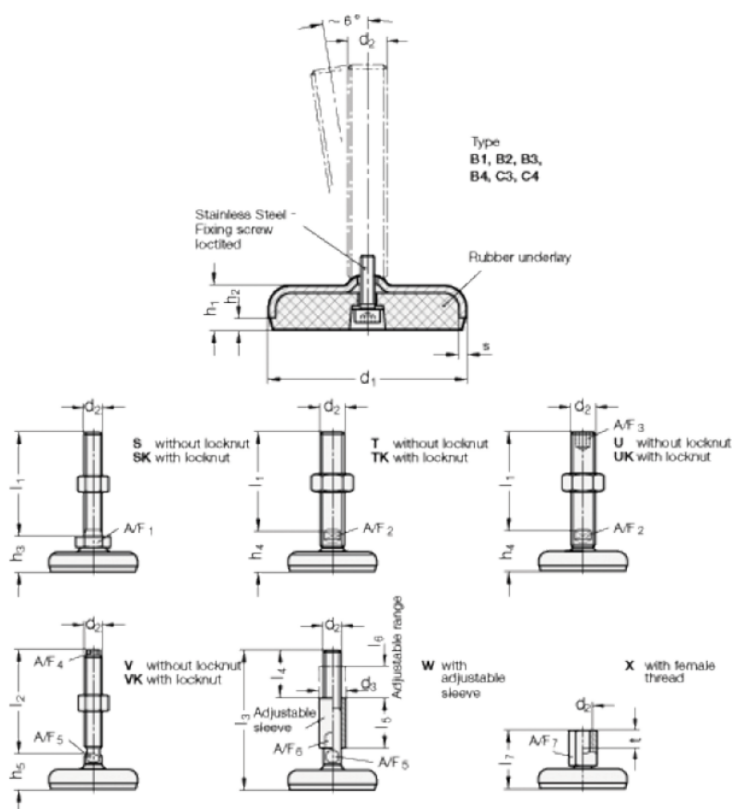

A/F2	= 12
d1	= 60
d2	= 16
h1	= 16
h2	= 4
h4 +4.0/0	= 30
l1	= 150
s	= 3